



## Schließrechte zuweisen - normale Benutzerkeys Allocating locking authorisations - normal user keys



231.07.070

	 Masterkey / Programming key	 Benutzerkey / User key
<b>Masterkey anlernen / Assigning master key</b>		
<div style="display: flex; justify-content: space-between;"> <div style="width: 45%;"> </div> <div style="width: 50%;"> <p><b>de</b> (1) Push-Button ca. 5 Sek. drücken. Tickendes Geräusch. (2) Masterkey an Schloss halten. Masterkey 1: 1x Beep; Masterkey 2: 2x Beeps.</p> <p><b>en</b> (1) Press the push button for approx. 5 sec. A ticking sound can be heard. (2) Hold the master key in front of the lock. Master key 1: 1x beep; master key 2: 2x beep.</p> </div> </div>		
<b>Benutzerkey anlernen / Assigning user key</b>		
<div style="display: flex; justify-content: space-between;"> <div style="width: 45%;"> </div> <div style="width: 50%;"> <p><b>de</b> (1) Masterkey an Schloss halten. Tickendes Geräusch. 1x Beep lang. (2) Benutzerkey an Schloss halten. 2x Beep kurz. Benutzerkey ist programmiert.</p> <p><b>en</b> (1) Hold the master key in front of the lock. A ticking sound can be heard. 1x long beep. (2) Hold the user key in front of the lock. 2x short beep. User key has been programmed.</p> </div> </div>		



732.22.013

HDE 03/2017

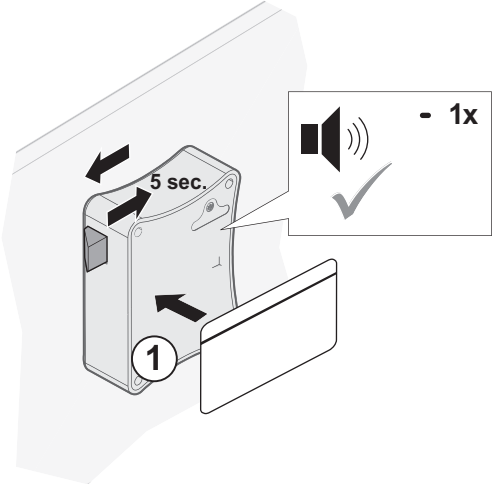
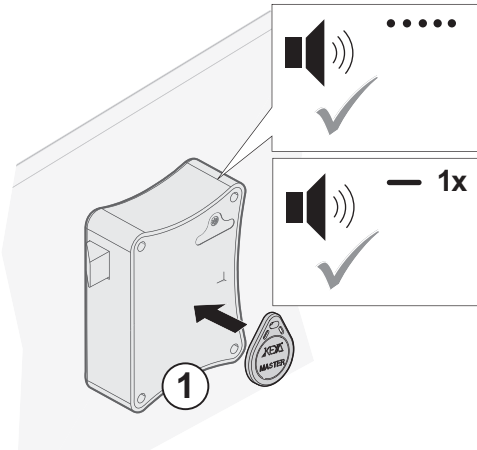
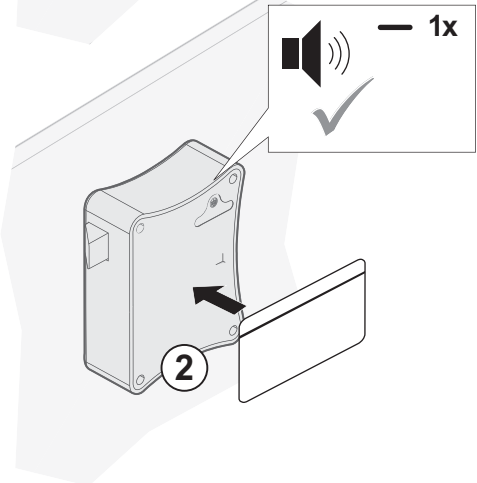
## Schließrechte zuweisen - normale Benutzerkeys Allocating locking authorisations - normal user keys

	 Masterkey / Programming key	 Benutzerkey / User key
Benutzerkey testen / Testing user key		
<div style="display: flex; justify-content: space-between;"> <div style="width: 40%;">  </div> <div style="width: 55%;"> <p><b>de</b> (1) Benutzerkey an Schloss halten. 1x Beep kurz. Riegel öffnet. Schließt nach 5 Sek.</p> <p><b>en</b> (1) Hold the user key in front of the lock. 1x short beep. Latchbolt opens. After 5 sec. it closes again.</p> </div> </div>		
Benutzerkey löschen / Erasing user key		
<div style="display: flex; justify-content: space-between;"> <div style="width: 40%;">  </div> <div style="width: 55%;"> <p><b>de</b> (1) Masterkey an Schloss halten. Tickendes Geräusch. 1x Beep lang.</p> <p>(2) Benutzerkey an Schloss halten. 1x Beep lang. Benutzerkey ist gelöscht.</p> </div> </div> <div style="display: flex; justify-content: space-between; margin-top: 20px;"> <div style="width: 40%;">  </div> <div style="width: 55%;"> <p><b>en</b> (1) Hold the master key in front of the lock. A ticking sound can be heard. 1x long beep.</p> <p>(2) Hold the user key in front of the lock. 1x long beep. User key has been erased.</p> </div> </div>		

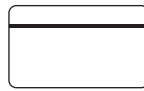
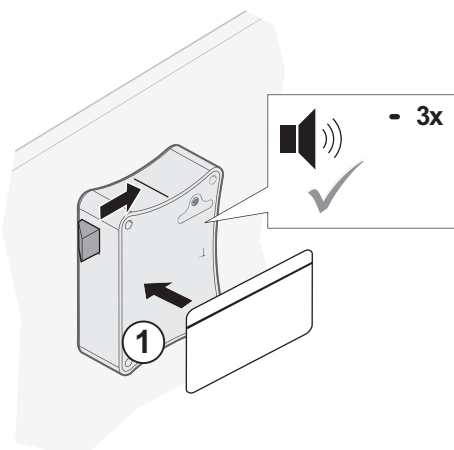
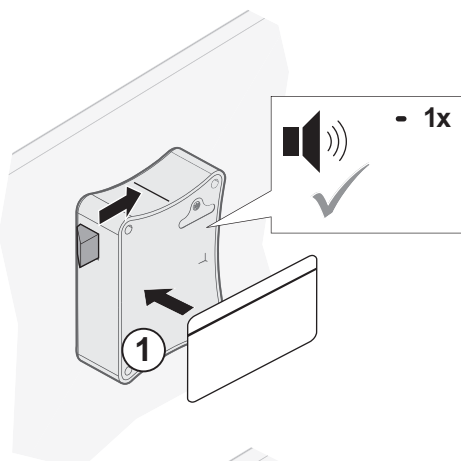
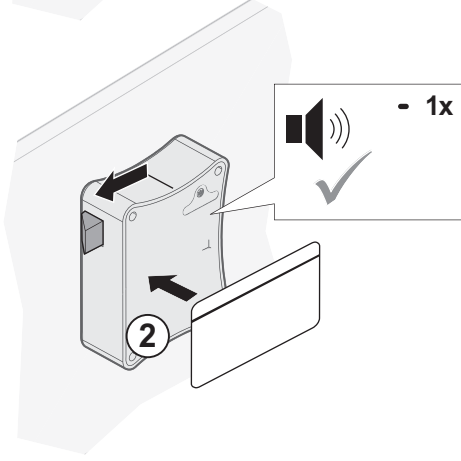

## Schließrechte zuweisen - normale Benutzerkeys Allocating locking authorisations - normal user keys

	 Masterkey / Programming key	 Benutzerkey / User key
Freie Schrankwahl einstellen / Setting free choice of locker function		
<div style="display: flex; justify-content: space-between;"> <div style="width: 30%;">  </div> <div style="width: 65%;"> <p><b>de</b> (1) Benutzerkey an Schloss halten. Riegel fährt ins Schloss. 3x Beep kurz.</p> <p><b>en</b> (1) Hold the user key in front of the lock. Latchbolt moves into lock. 3x short beep.</p> </div> </div>		
Benutzerkey im Modus „Freie Schrankwahl“ testen / Testing user key in "free choice of locker" mode		
<div style="display: flex; justify-content: space-between;"> <div style="width: 30%;">  </div> <div style="width: 65%;"> <p><b>de</b> (1) Benutzerkey an Schloss halten. 1x Beep kurz. Schloss öffnet.</p> <p>(2) Benutzerkey an Schloss halten. 1x Beep kurz. Schloss schließt.</p> <p><b>en</b> (1) Hold the user key in front of the lock. 1x short beep. Lock opens.</p> <p>(2) Hold the user key in front of the lock. 1x short beep. Lock closes.</p> </div> </div> <div style="display: flex; justify-content: space-between;"> <div style="width: 30%;">  </div> </div>		

732.22.013

HDE 03/2017

## Schließrechte zuweisen - Benutzerkeys Allocating locking authorisations - user keys

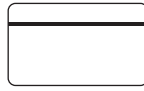
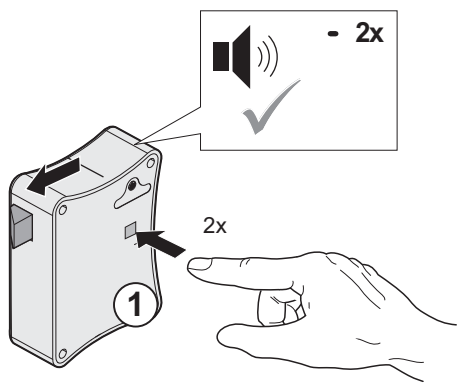
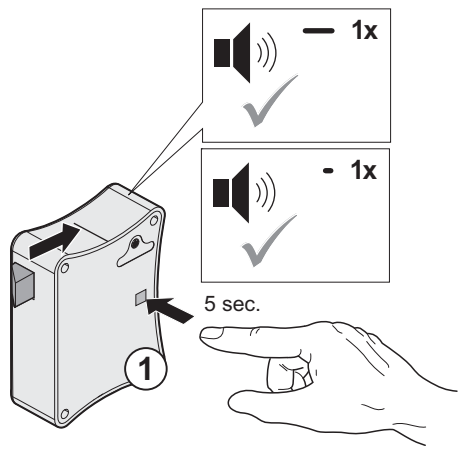
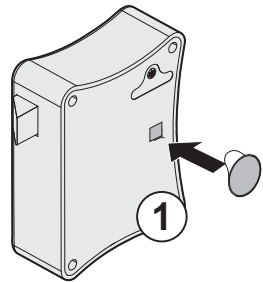
	 Masterkey / Programming key	 Benutzerkey / User key
Feste Schrankzuordnung einstellen / Setting fixed locker allocation function		
<div style="display: flex; justify-content: space-between;"> <div style="width: 30%;">  </div> <div style="width: 65%;"> <p><b>de</b> (1) Push-Button 2x drücken. Riegel fährt aus. 2x Beep kurz.</p> <p><b>en</b> (1) Press the push button twice. Latchbolt is extended. 2x short beep.</p> </div> </div>		
Reset / Reset		
<div style="display: flex; justify-content: space-between;"> <div style="width: 30%;">  </div> <div style="width: 65%;"> <p><b>de</b> (1) Push-Button 5 Sek. gedrückt halten. 1x Beep lang, 1x Beep kurz. Riegel fährt in das Schloss.</p> <p><b>en</b> (1) Press the push button and hold it down for approx. 5 sec. 1x long beep, 1x short beep. Latchbolt moves into lock.</p> </div> </div>		
Abschluss der Programmierung / Completing the programming		
<div style="display: flex; justify-content: space-between;"> <div style="width: 30%;">  </div> <div style="width: 65%;"> <p><b>de</b> (1) Nach Abschluss der Programmierung die Öffnung für den Push-Button mit einem Aufkleber verschließen.</p> <p><b>en</b> (1) After completion of programming, block the opening for the push button with a sticker.</p> </div> </div>		

## Bedienung Operation

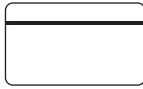

Benutzerkey / User key

Multi-User-Code: öffnen/schließen / Multi user code: opening/closing

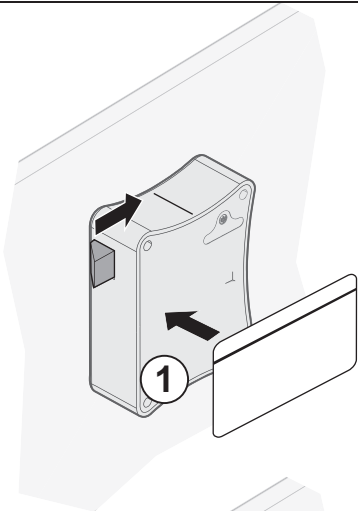

**de** (1) Benutzerkey vorhalten. Schloss öffnet sich.

**en** (1) Present user key. Lock opens.

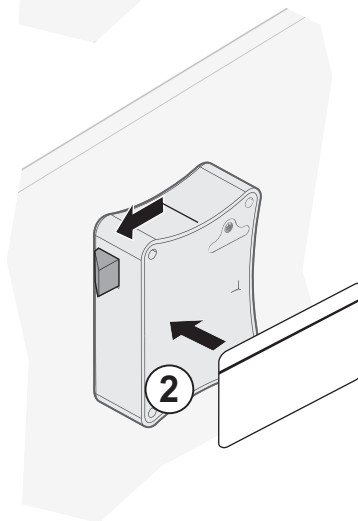

**de** (2) Benutzerkey vorhalten. Schloss schließt.

**en** (2) Present user key. Lock closes.

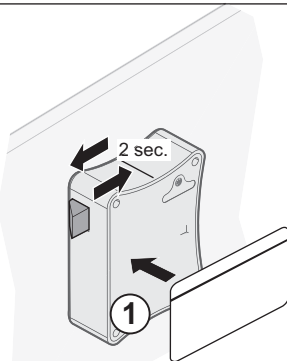

Single-User-Code: öffnen/schließen / Single user code: opening/closing



**de** (1) Benutzercode vorhalten. Schloss öffnet.  
Nach 2 Sek. schließt das Schloss.

**en** (1) Present user code. Lock opens.  
Lock closes again after 2 seconds.

## Bedienung / Operation

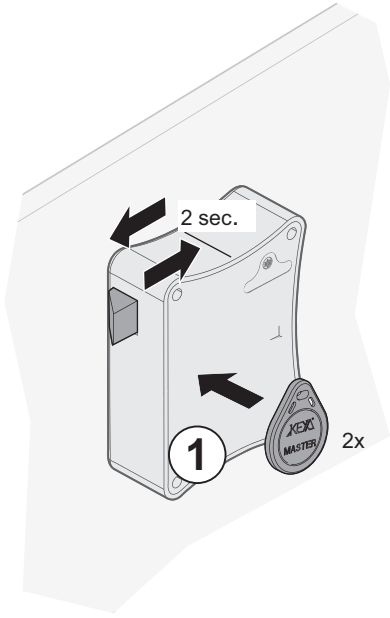
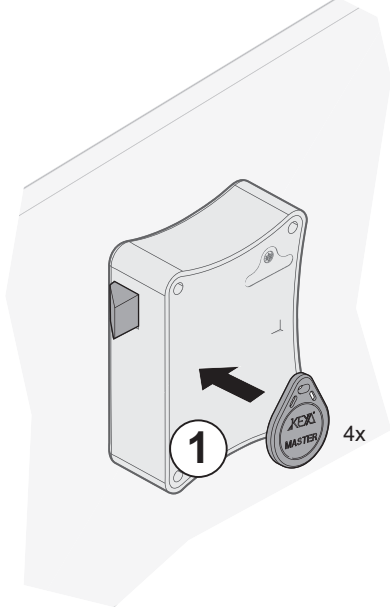
	 <p>Masterkey / Programming key</p>
<p>Inspection-Code: öffnen/schließen / Inspection code: opening/closing</p>	
	<p><b>de</b> (1) Masterkey vorhalten. Schloss öffnet sich. Schloss schließt nach 2 Sek. automatisch.</p> <p><b>en</b> (1) Present master key. Lock opens. Lock closes automatically after 2 seconds.</p>
<p>Master-Code: öffnen / Master code: opening</p>	
	<p><b>de</b> (1) Masterkey 4x vorhalten</p> <p><b>en</b> (1) Present master key four times.</p>

## Batteriewechsel Battery change

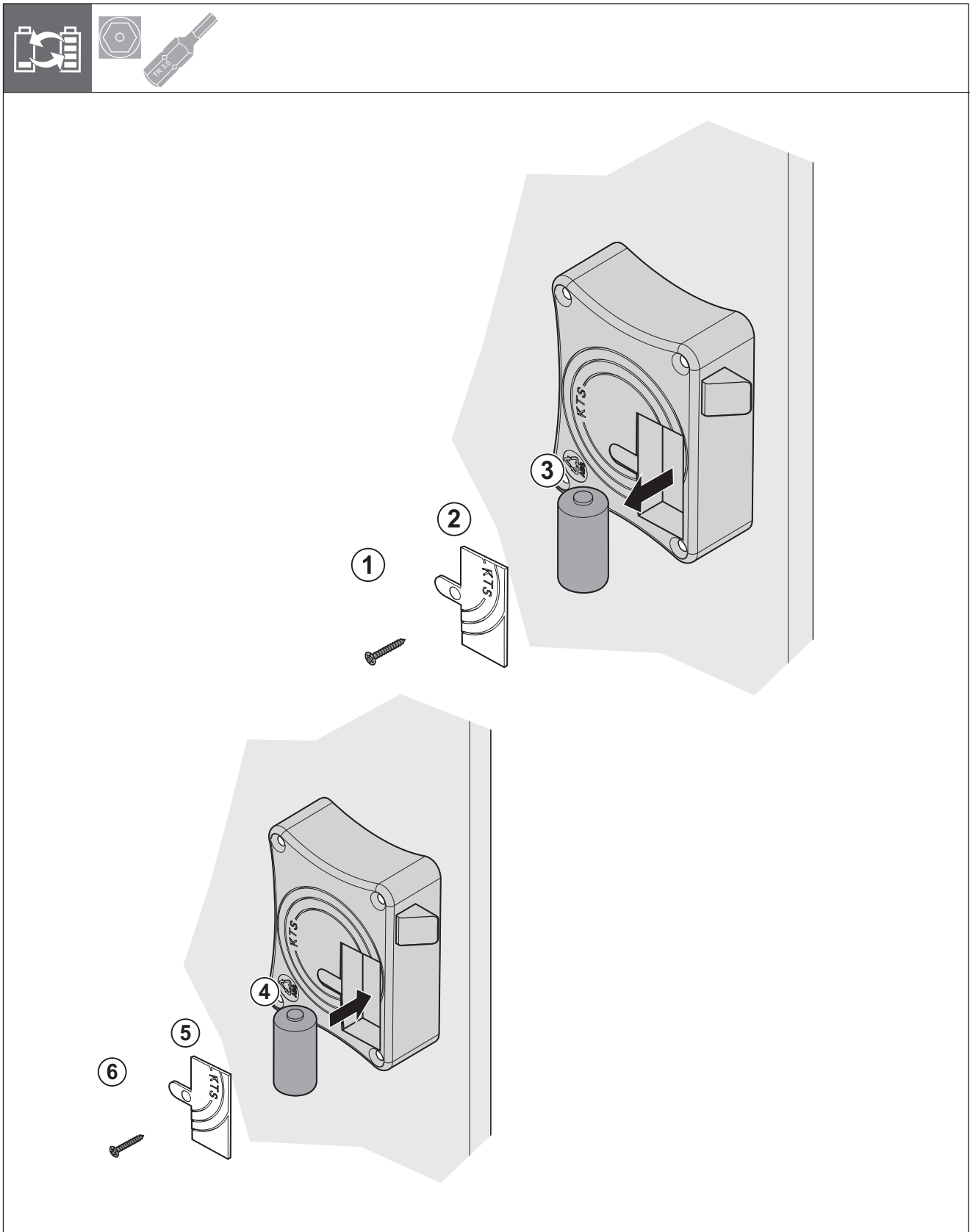

732.22.013

HDE 03/2017